

Please write clearly in block capitals.

Centre number

--	--	--	--	--

Candidate number

--	--	--	--

Surname

Forename(s)

Candidate signature

I declare this is my own work.

GCSE COMBINED SCIENCE: TRILOGY

H

Higher Tier
Physics Paper 2H

Friday 12 June 2020

Morning

Time allowed: 1 hour 15 minutes

Materials

For this paper you must have:

- a protractor
- a ruler
- a scientific calculator
- the Physics Equations Sheet (enclosed).

Instructions

- Use black ink or black ball-point pen.
- Pencil should only be used for drawing.
- Fill in the boxes at the top of this page.
- Answer **all** questions in the spaces provided.
- Do all rough work in this book. Cross through any work you do not want to be marked.
- If you need extra space for your answer(s), use the lined pages at the end of this book. Write the question number against your answer(s).
- In all calculations, show clearly how you work out your answer.

Information

- The maximum mark for this paper is 70.
- The marks for questions are shown in brackets.
- You are expected to use a calculator where appropriate.
- You are reminded of the need for good English and clear presentation in your answers.

For Examiner's Use	
Question	Mark
1	
2	
3	
4	
5	
6	
7	
TOTAL	



0 1

Figure 1 shows five different metal samples.

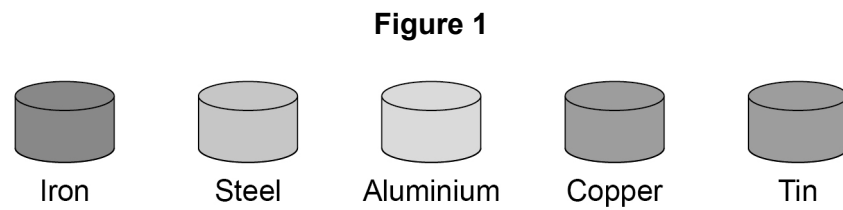

0 1 . 1

A student placed a magnet close to each metal sample.

Describe what happened.

[2 marks]

Figure 2 shows a paper clip being attracted to a permanent magnet.

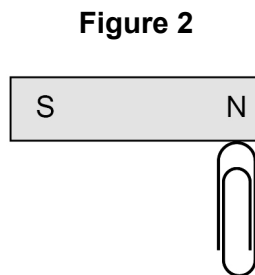

0 1 . 2

The paper clip in **Figure 2** is not a permanent magnet.

Explain what would happen if the paper clip was removed and brought close to the south pole of the permanent magnet.

[2 marks]



0 1 . 3

Write down the equation that links gravitational field strength (g), mass (m) and weight (W).

[1 mark]

0 1 . 4

The student added more paperclips to one end of the magnet.

The maximum number of paperclips the magnet could hold was 20

Each paper clip had a mass of 1.0 g

gravitational field strength = 9.8 N/kg

Calculate the maximum force the magnet can exert.

[3 marks]

Force = _____ N

8

Turn over for the next question**Turn over ►**

Table 1 shows the results.

Table 1

Height of ramp in metres	0.1	0.2	0.3	0.4	0.5	0.6
Acceleration in m/s^2	0.9	1.3	2.1	3.2	3.9	4.3

The first two results have been plotted on Figure 4.

Figure 4

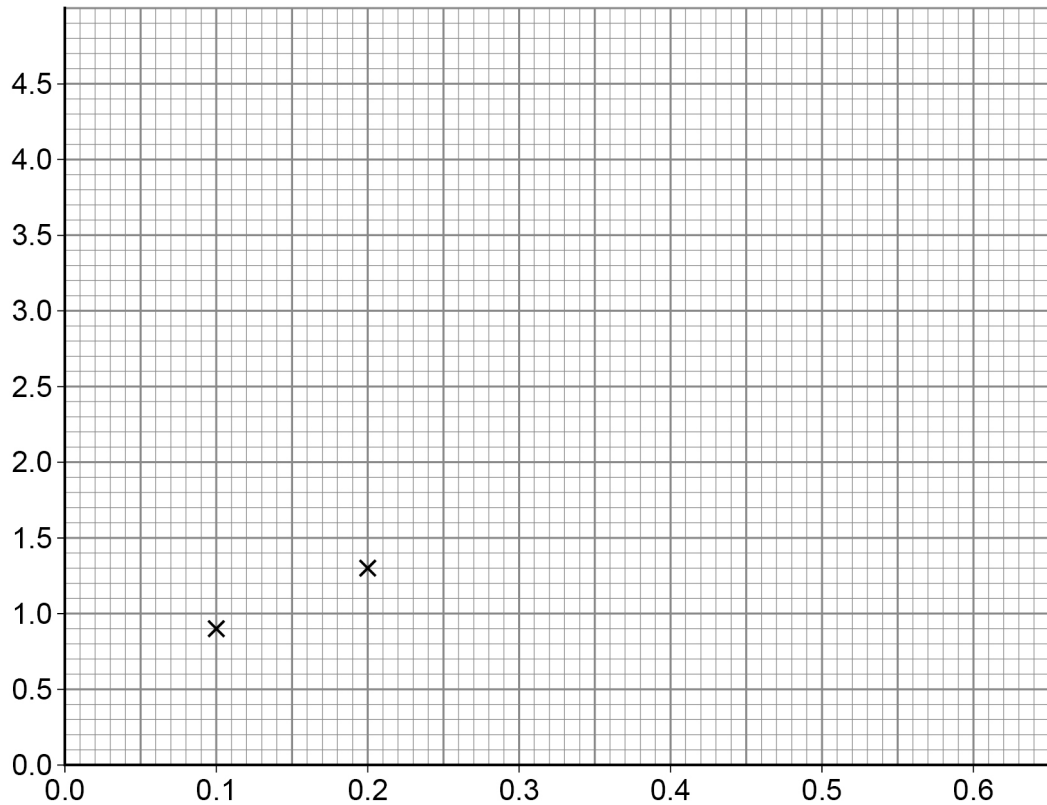

0 2 . 2 Complete Figure 4.

You should:

- label the axes
- plot the remaining results from **Table 1**
- draw a line of best fit.

[4 marks]

Question 2 continues on the next page

Turn over ►



0 2 . 3

Write down the equation that links acceleration (a), mass (m) and resultant force (F).**[1 mark]**

0 2 . 4

When the resultant force on the trolley was 0.63 N the acceleration of the trolley was 2.1 m/s^2

Calculate the mass of the trolley.

[3 marks]

Mass of trolley = _____ kg

14

0 3

Figure 5 shows a computer keyboard.

There is a spring under each key.

Figure 5

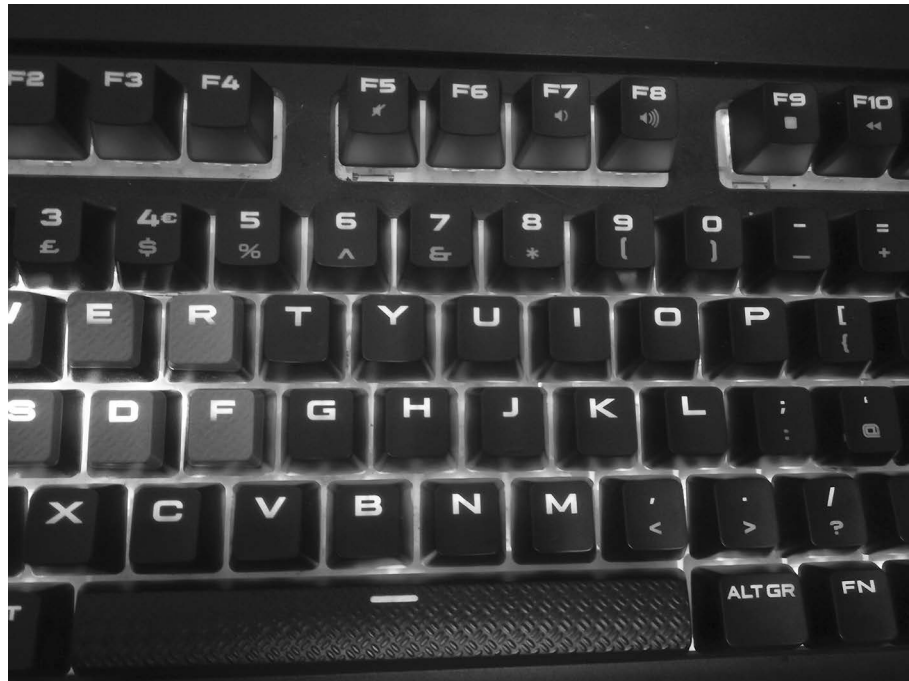

0 3

. 1

The springs behave elastically when a force is applied.

What is meant by elastic behaviour?

[1 mark]

Tick (✓) **one** box.

The spring will be compressed when the force is applied to it.

The spring will become deformed when the force is applied to it.

The spring will become longer when the force is removed.

The spring will return to its original length when the force is removed.

Turn over ►



0 3 . 2 Suggest **two** properties that should be the same for each spring.

[2 marks]

1 _____

2 _____

0 3 . 3 **Figure 6** shows one of the keys and its spring.

Figure 6

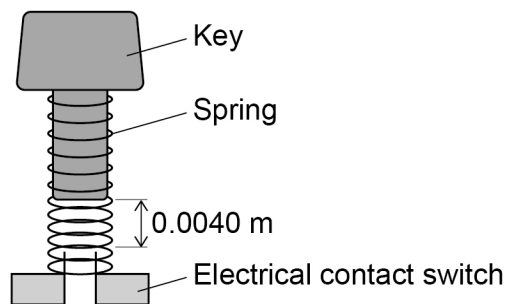

The key must be pressed with a minimum force of 0.80 N before the key touches the switch.

Calculate the spring constant of the spring in **Figure 6**.

[3 marks]

Spring constant = _____ N/m



0 3 . 4 **Figure 7** shows a spring that has been hung from a support.

The spring is stationary and has been stretched beyond its limit of proportionality.

Figure 7

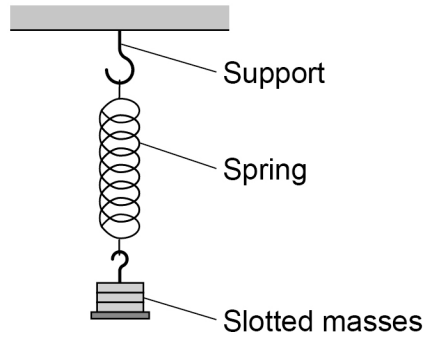

Which **two** statements are true for the spring in **Figure 7**?

[2 marks]

Tick (✓) **two** boxes.

The elastic potential energy of the spring is zero.

The extension of the spring is directly proportional to the force applied.

The upward force on the spring is equal to the downward force.

The spring cannot be stretched any further.

The spring is inelastically deformed.

8

Turn over for the next question

Turn over ►



0 4

Figure 8 shows a girl bowling a ball along a ten-pin bowling lane.

Figure 8



The girl is trying to knock down the ten pins at the end of the bowling lane.

0 4 . 1

Velocity is a vector quantity, speed is a scalar quantity.

Describe what is meant by a vector quantity and a scalar quantity.

[2 marks]

Vector quantity _____

Scalar quantity _____

0 4 . 2

The bowling lane is horizontal.

Explain why the bowling ball decelerates as it travels along the lane.

[2 marks]



Figure 9 shows the bowling ball hitting one of the pins.

Figure 9

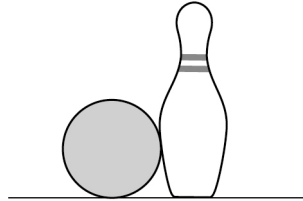

0 4 . 3 Write down the equation that links mass (m), momentum (p) and velocity (v).

[1 mark]

0 4 . 4 The bowling ball has a velocity of 5.0 m/s when it hits the pin.

The momentum of the bowling ball is 26 kg m/s

Calculate the mass of the bowling ball.

[3 marks]

Mass = _____ kg

Question 4 continues on the next page

Turn over ►



0 4 . 5 Explain why the bowling ball slows down when it hits the pin.

You should use ideas about momentum in your answer.

[3 marks]

11



0 5

X-rays form part of the electromagnetic spectrum.

Radiographers use X-rays to produce images of bones inside the body.

0 5 . 1

Explain why X-rays can be used to produce images of the bones inside the body.

[2 marks]

0 5 . 2

Table 2 shows the effect of exposure to different doses of radiation.

Table 2

Dose in mSv	Effect on the human body
100	slightly increased risk of cancer
1000	5% increased risk of cancer
5000	high risk of death

During an X-ray a person receives a dose of 0.5 mSv

The radiographer takes many X-ray images each day.

Explain why the radiographer stands behind a protective screen when taking an X-ray image.

[3 marks]

Turn over ►

0 5 . 3 Radio waves form part of the electromagnetic spectrum.

Figure 10 shows one use of radio waves.

Figure 10

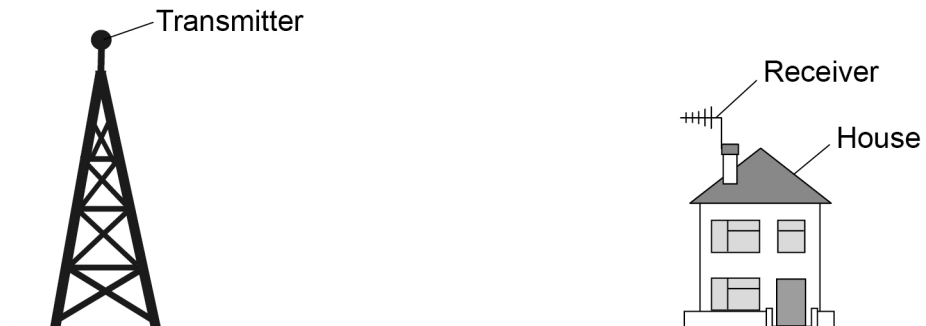

Explain how electrical signals in the transmitter produce a signal in the receiver.

[3 marks]

8



0 6

The speed limit on many roads in towns is 13.5 m/s

Outside schools this speed limit is often **reduced by** one-third.

0 6 . 1

Calculate the reduced speed limit.

[2 marks]

Reduced speed limit = _____ m/s

0 6 . 2

A reduced speed limit may reduce air pollution.

Explain **one** other advantage of a reduced speed limit.

[2 marks]

Question 6 continues on the next page

Turn over ►

0 6 . 3

Figure 11 shows a car being driven at a constant speed past a speed camera.

Figure 11



Speed camera

Car

The camera recorded two images of the car 0.70 s apart.

The car travelled 14 m between the two images being taken.

The maximum deceleration of the car is 6.25 m/s^2

Calculate the minimum braking distance for the car at the speed it passed the speed camera.

[6 marks]

Minimum braking distance = _____ m



0 6 . 4 Figure 12 shows a delivery van full of packages.

Figure 12



Packages

The driver delivers all the packages.

The empty van has a shorter stopping distance than the full van when driven at the same speed.

Explain why.

[3 marks]

13

Turn over for the next question

Turn over ►



07

A student clamped a wire between the poles of a permanent magnet.

The student investigated how the force on the wire varied with the current in the wire.

Figure 13 shows the equipment used.

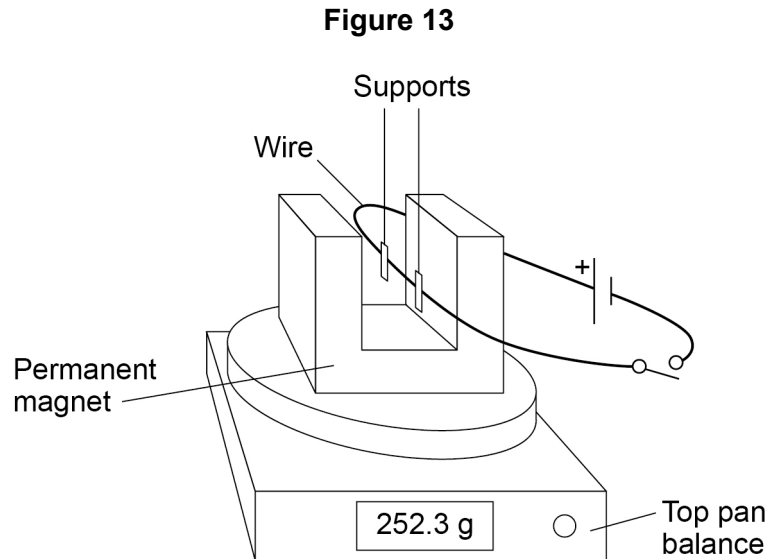

The top pan balance was used to determine the force on the wire.

07

.1

When the switch was closed the reading on the top pan balance increased.

Explain why the increased reading showed that there was an upward force on the wire.

[2 marks]



0 7 . 2

Table 3 shows the readings on the top pan balance with the switch open and with the switch closed.

Table 3

Switch	Mass in grams
Open	252.3
Closed	254.8

Explain how the values in **Table 3** can be used to determine the size of the force on the wire.

[2 marks]

Question 7 continues on the next page

Turn over ►

0 7 . 3

The student varied the current in the wire and calculated the force acting on the wire.

Figure 14 shows the results.

Figure 14

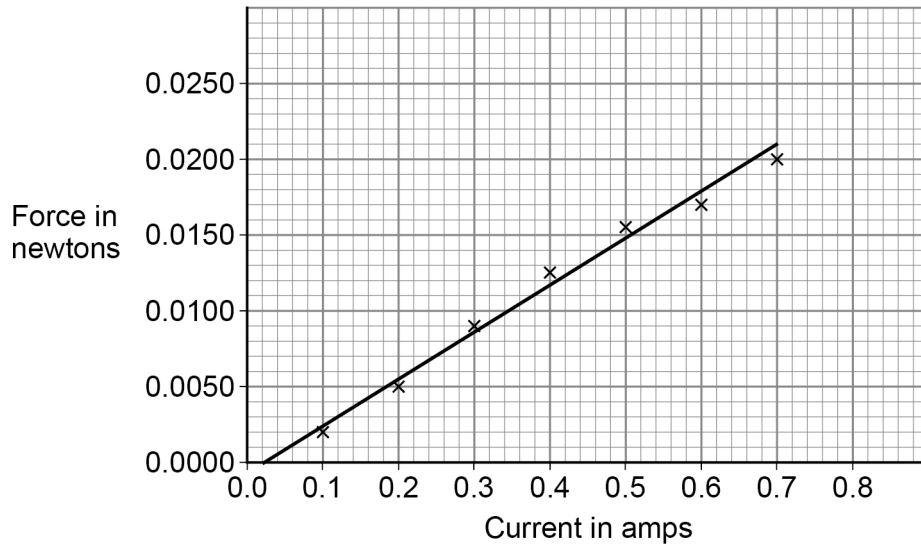

The length of the wire in the magnetic field was 0.125 m

Determine the magnetic flux density.

[4 marks]

Magnetic flux density = _____ T

8

END OF QUESTIONS



There are no questions printed on this page

*Do not write
outside the
box*

**DO NOT WRITE ON THIS PAGE
ANSWER IN THE SPACES PROVIDED**



